

TAB Polar Truck

ORDER INFORMATION

Short code	TR24
TAB ID	
DIN marking	70027
Quantity per EUR/CNT pallet	18/24 Pcs

TECHNICAL INFORMATION

Voltage	12 V
Capacity C20	240 Ah
CCA -18°C EN	1150 A

DIMENSION AND WEIGHTS

Length/Width/Height	517x275x214/236 mm
Lead weight	31.8 kg
Electrolyte weight	25.2 kg
Total weight	57.0 kg

TECHNOLOGY

Type	Flooded
Grid type	Casted/Expanded
Grid alloy	Sb/Ca
Separator	PE
Electrolyte	1.28 g/cm ³

BOX DESIGNS

Container type	C
Colour	Black
Polarity	3
Base hold down	B0
Cover type	Flat
Layout	3
Terminal	1

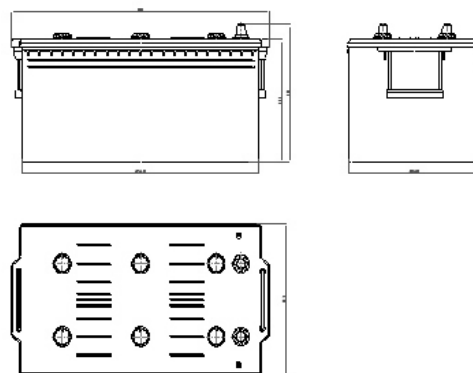

Base hold down



Layout

